

# GD SODA

## USER MANUAL

Be sure to read this manual in detail and keep it properly



GUNGDAI TECHNOLOGY CO., LTD.  
17F., NO. 2-106, WUQUAN RD., WEST DIST., TAICHUNG TAIWAN, 40355  
<https://www.gungdai.com.tw/en>

# Safety Instructions



**Please read the following instructions carefully.**

**When operating electronic devices, please comply with the basic safety precautions and descriptions below:**

1. Do not place power cords, plugs, or devices in water or other liquids to avoid electric shock.
2. Do not operate if the power cord or plug is damaged, or if the device is malfunctioning. Please return the device for further inspection, repair, or adjustment.
3. Do not use the device outdoors or in damp areas.
4. Do not let the power cord hang over the edge of a table or counter, or contact hot surfaces.
5. Do not use this device for other purposes besides home use.
6. When using this equipment, keep two to three inches of space around the device for a good ventilation.
7. Do not attempt to repair the product yourself. Repairs should be carried out by qualified technician.
8. Keep children away from operation. Hot water can cause severe scalds.
9. This appliance is not intended for use by persons including children with reduced physical, sensory, or mental capabilities, or lack of experience and knowledge, unless they have been given supervision or instruction concerning use of the appliance by a person responsible for their safety.
10. Children must be supervised to ensure that they don't play with the appliance.
11. If the power cord is damaged, it must be replaced by the manufacturer, its service agent, or similarly qualified persons in order to avoid a hazard.
12. Please use the new tubes that supplied with the appliance, do not use the old tubes.
13. Avoid splashing liquids on the connector.
14. There may be residual heat retained on the faucet after use, so please do not touch the faucet body to avoid scalds.

# Installation

## Parts and Materials Needed

### Materials

1. 1/2" or 3/4" water T-adapter
2. Stop valve
3. 1/4" valve
4. 1/4" RO tube, length adjust as needed

### Tools

1. Phillips screwdriver
2. Power drill
3. Pilot drill as needed
4. Safety goggles
5. Bucket
6. Pliers
7. Gloves
8. 35mm hole opener
9. Pipe cutter
10. Thread seal tape
11. Adjustable wrench

### Site Requirements

1. A filtered or clean water source is required.
2. A drainage system is required.
3. A dedicated (110V 15A/220V 15A) power supply is required. The use of extension cords is not recommended.

-  1. All tubes are NSF/FDA certified, non-toxic TPFE tubes.
- 2. This product cannot continuously produce hot water. The standard model produces 60 cups (300 ml) of hot water per hour.

 **Required materials must be prepared by the installation personnel and in compliance with local regulations.**

# Faucet Dimensions

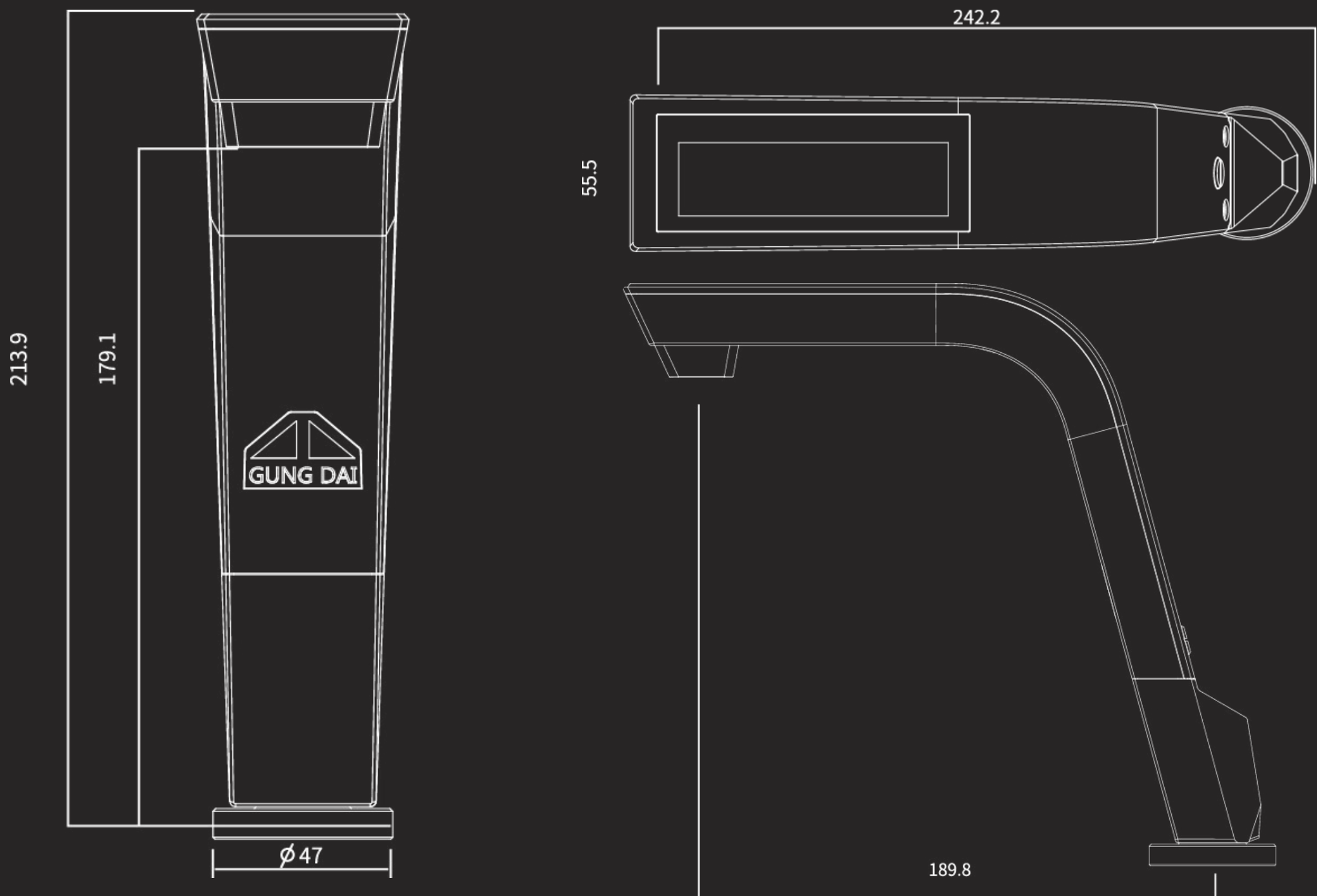

- 1. Faucet Installation Hole: Diameter 35 mm
- 2. Faucet Rotation: 150 degree

# Parts and Specifications

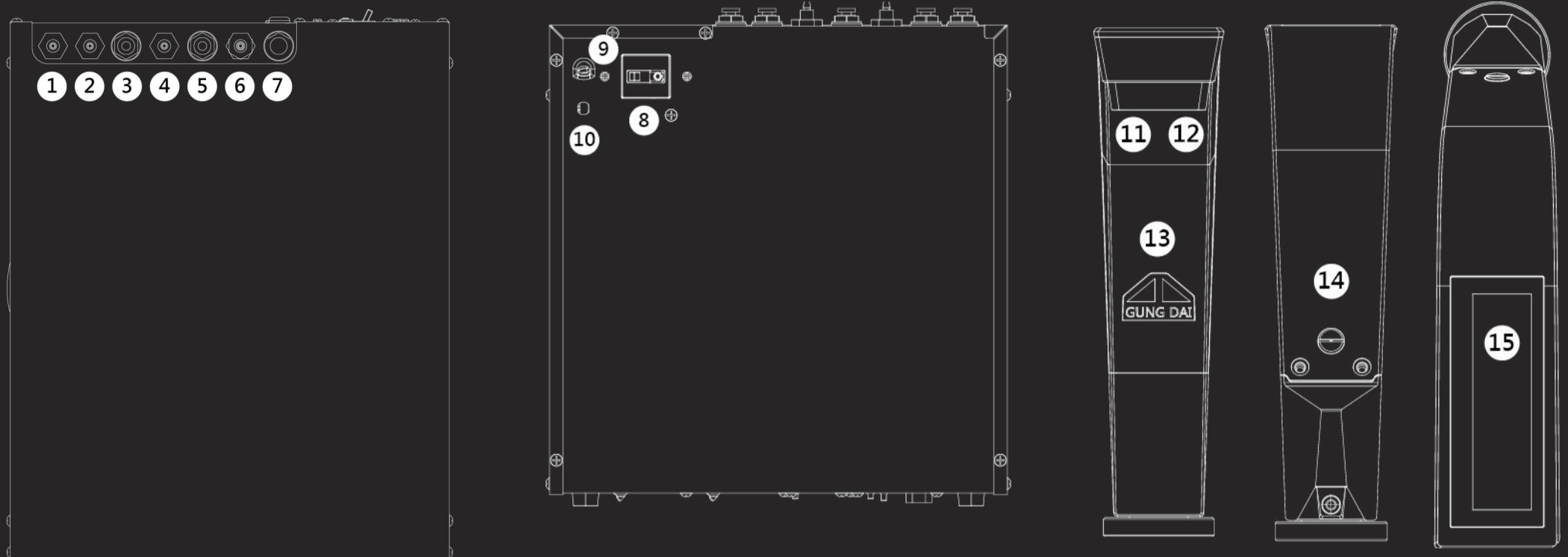

## Parts

1. Hot water outlet (main unit)
2. Air vent (main unit)
3. Cold/soda/ambient water outlet
4. Water source inlet
5. CO2 inlet
6. Cooling water inlet
7. Cooling water outlet
8. Power switch (RCCB)
9. Power cord
10. Faucet signal cable
11. Hot water outlet (faucet)
12. Ambient/Cold/Soda outlet (faucet)
13. LOGO indicator light (Red: heating/Blue: thermostat)
14. Air vent (faucet)
15. Smart touchscreen

## Items

## Specifications

Voltage	110V / 60Hz, 220V / 50Hz
Main Unit Dimensions	34.5(W)×42.5(D)×35.1(H) cm
Water Pressure	45 PSI
Power Cord	3x2.0mm
Capacity	2.2 L (Hot) / 2.0 L (Cold)
Power Consumption	1350 W
Heating Capacity	10L/h
Cooling Capacity	5L/h
Hot tank	ST-304 (Stainless Steel)
Heating Element	ST-316 Medical grade ring type heater
Country of Origin	Taiwan
Faucet Installation Hole	35mm Diameter

# Installation Diagram

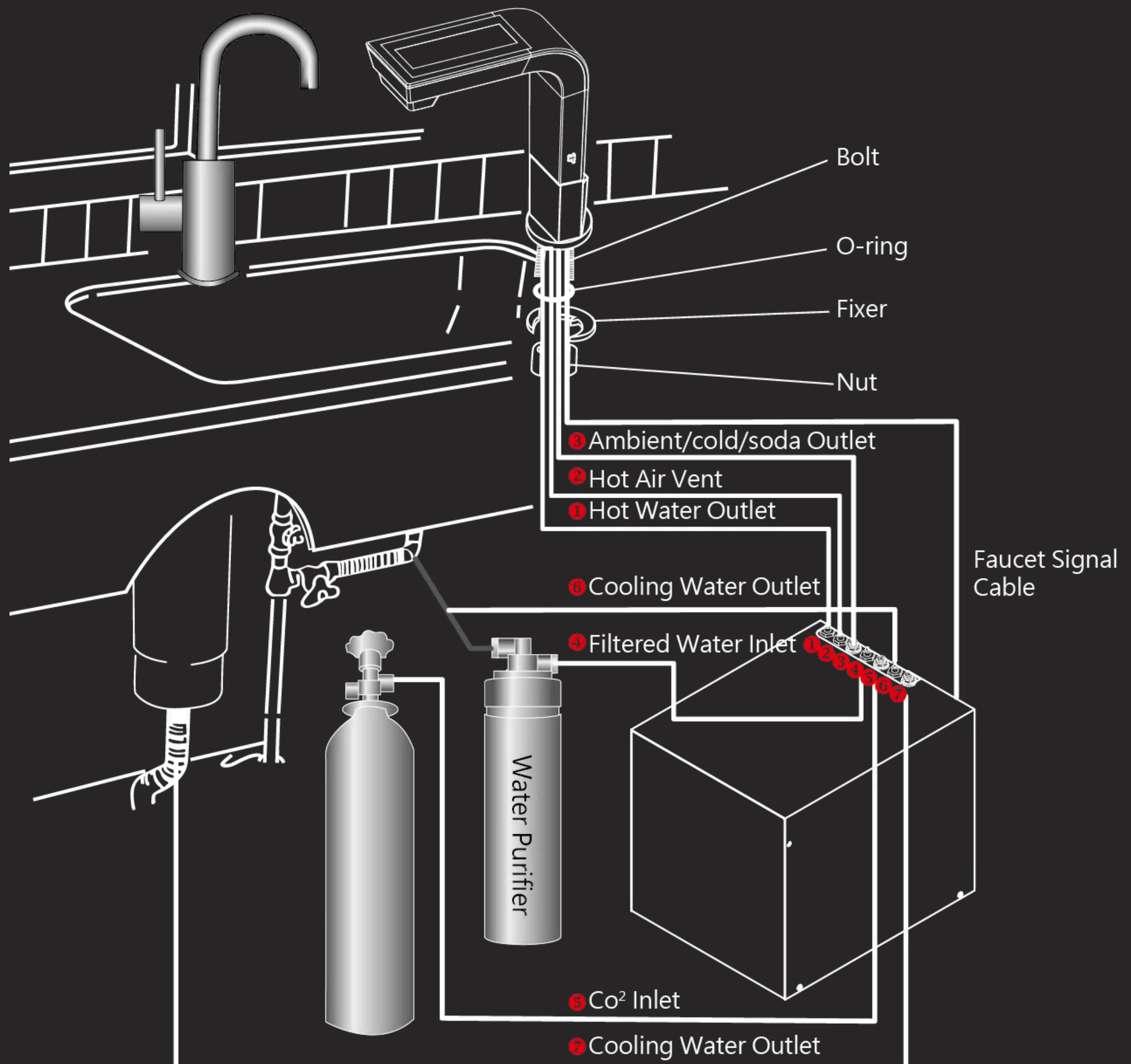

- ⚠ 1. Before connecting the GD SODA to a power source, please ensure that the voltage, current, and power cord specifications match the instructions. Unauthorized changes to the power source or device structure may cause malfunctions or hazards. We are not responsible for any personal injury or property damage resulting from failure to follow these instructions.
2. Must use a dedicated outlet and be connected to a dedicated earth wire. Do not use an extension lead.
3. Please install a leakage breaker at the water filtration end to ensure safety.
4. Please install a relief valve if the water pressure exceeds 45 PSI.
5. Please ensure the hot-resistant tube is not twisted or knotted. The hot tank must be installed vertically, and the tube can be shortened if necessary.
6. Do not use adhesive for faucet installation.



# Initial Setup

## Enter the Dealer-exclusive Password

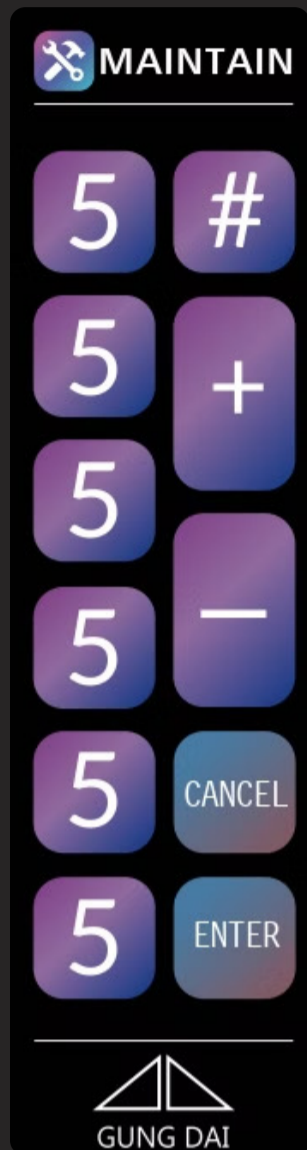

- ⚠ 1. Please enter the **dealer-exclusive password**. Example: 11111→#→ENTER (Please contact the original vendor if you don't know the password.)
- 2. Please keep the operation panel dry. (If the panel malfunctions due to moisture, please wipe the panel dry before operating.)
- 3. If the password is entered incorrectly three times, please notify the original vendor for further assistance.

1. Press the numeric buttons to select.
2. 1. Use the (+/-) buttons to adjust.
3. 1. Press ENTER to confirm.





## Set Date/Time/Week



Turn on the power of the main unit. First press the LOGO then quickly press the HOT water buttons for 3-5 seconds to access the Time & Date setup page.

1. Press Return	2. Press LOGO then HOT	3. Set Date	4. Set Time	5. Set Week





# Operation Menu

## User Menu

	<b>UNLOCK</b> Unlock before press hot water
	<b>HOT</b> Dispense hot water
	<b>AMBIENT</b> Dispense ambient water
	<b>COLD</b> Select cold/soda water
	<b>RETURN</b> Return to home page





	<b>SODA</b> Press COLD → Press SODA to dispense soda water
	<b>REBOIL</b> Reboil water
	<b>SETUP</b> Enter to setup page



## Setup Menu

	<b>TEMP</b> Select 3 temperature modes 70/85/98 °C
	<b>FILTER</b> Filter lifespan check
	<b>ECO</b> Set a specific energy saving time
	<b>MAINTAIN</b> To access engineering mode
	<b>COLD ON/OFF</b> Turn on/off cooling system



# Operation Menu (Technician)

	<b>Engineering Menu</b>
	<b>Filter</b> <b>RESET</b> - Reset the filter cartridge lifespan (default 12 months) <b>RECORD</b> - Check filter replacement records
	<b>LIFESPAN</b> Set a specific timer for filter lifespan (1-12 months)
	<b>ERROR</b> Check error records
	<b>FLOW</b> Check filtered volume

 	<b>Set Motor Speed</b> Press LOGO and SETUP button simultaneously for 3-5 seconds to enter motor speed adjustment mode
	The default setting of motor speed is 60% at first 5 seconds then it speeds up to 90% for water dispensing. You may increase the motor speed in case of lower water flow.

	<b>Reset filter lifespan</b> Press FILTER button to enter filter setting
<b>RESET</b>	Press RESET to reset filter lifespan
<b>RECORD</b>	Press RECORD to check filter cartridge replace history
<b>RETURN</b>	Press RETURN to main menu

# Error Codes

**E1** Hot water temperature sensor malfunction (Failure to detect hot water temperature)

Replace hot water temperature sensor (Technician)

**E2** Heating exceeds 60 minutes

1. Check if electric heating connector is loose (Technician)
2. Check if the small thermostat is malfunction (Technician)
3. Return to local service center for further inspection

**E3** High water level not detected

1. Check if the water source fills normal
2. Check if the filter is clogged

**E4** Low water level not detected

1. Check if the water source fills normal
2. Check if the filter is clogged

**E5** Water leakage

Check if there is a leak inside the water dispenser. If there is a leak, fix it and dry the detector (Technician).

**E6** Cable signal abnormal

Return to local service center for further inspection

**E7** Low water level not detected, but high water level detected (indicating low water level switch abnormality)

Replace water level probe assembly including water level probe silicone plug (Technician)

**E10** Compressor abnormal

Return to local service center for further inspection

**E11** Cold water temperature sensor abnormal (unable to detect cold water temperature)

Replace cold water temperature sensor

**E12** Ambient water temperature sensor abnormal (unable to detect ambient water temperature)

Replace ambient water temperature sensor

# Troubleshooting

**Q** Why is there a difference between the actual water temperature and the temperature displayed on the panel?

**A** The actual temperature of the hot water is affected by the ambient temperature of the tube connecting the hot tank to the faucet. The longer the tube, the bigger the effect.

**Q** Why does the faucet drip during the heating process?

**A** To prevent the issues like excessive pressure and sewage backflow, all GD series hot tanks are equipped with pressure relief system. As a result, during the heating process, the steam converts to water and is discharged from the faucet which is a normal circumstance. This can also happen if the water input pressure is below 20 PSI; adjusting the pressure appropriately can fix the problem in this case.

**Q** What is the reason for the main unit leaking?

**A** It could be that the hot water tube was bent during installation, causing back pressure and resulting in leaking. Please turn off the the water source switch and unplug the power cord from the socket.

Then, please contact your maintenance personnel for an on-site inspection.

**Q** Why are there white sediments appearing in the water after using water dispensers for a while?

**A** It's normal for water to contain trace minerals naturally. Magnesium and calcium can form white sediment when heated. These sediments are harmless when consumed in small amounts. However, we strongly recommend performing a major maintenance every four years to ensure the longevity and sanitation of your device.

**Q** Does the heater of the GD water dispensers release contaminant during the heating process?

**A** All heaters in the GD series water dispensers are UL certified by the United States and made with medical-grade ST-316 stainless steel. They are completely harmless and do not release contaminants like other copper heaters. Moreover, GD's heater are two times bigger than the traditional type, which are more efficient and energy-saving.

**Q** Does the GD series water dispenser require regular maintenance?

**A** Yes, we recommend performing major maintenance for your GD series water dispenser at least every four years, and more frequently if the source water in your area is lower quality. This keeps the longevity and hygienic for your water dispenser.

Please contact your maintenance personnel for further detail.

# Troubleshooting

**Q** Why the capacity of GD series hot tanks is smaller than other brands?

**A** The hot tanks in GD series water dispensers are intentionally designed smaller because consumer habit analysis revealed that a 2.4-liter hot tank is sufficient for general once consumption. This design primarily enhances energy efficiency and positions GD ahead of competitors.

**Q** Where are GUNGDAI products made?

**A** The GUNGDAI series are 100% made in Taiwan. GUNGDAI, hereinafter referred as GD, is a Taiwanese brand with a global presence. Renowned for its top-notch quality, excellent artwork design and impeccable craftsmanship. GD stands as a premium home appliance brand that perfectly integrates into any luxury interior decorations, making it the go-to choice for those who settle for nothing but the best.

**Q** What is the power consumption of the hot drink machine in standby mode?

**A** The power consumption is about 486 W a day.

**Q** Why does the drinking water have an odor?

**A** The taste, smell and odors are mainly related to water filter cartridges.

This could be due to a change in your water usage habits or not replacing the filter regularly. If you are used to drinking RO purified water and suddenly switch to mineral water, the change in mineral content can alter the taste and affect the drinking experience.

If you have any other issues or need service, please contact your local service provider.

# Restricted Substances List (RSL)

	Power Cord [1]	Metal Parts [2]	PCB Assemblies [3]	Plastic Parts [4]
Lead (Pb)	○	○	○	○
Mercury (Hg)	○	○	○	○
Cadmium (Cd)	○	○	○	○
Hexavalent Chromium (Cr <sup>6+</sup> )	○	○	○	○
Polybrominated Biphenyls (PBB)	○	○	○	○
Polybrominated Diphenyl Ethers (PBDE)	○	○	○	○

[1] Including internal and external wiring

[2] Including heating plates, screws, outer casing, heating elements

[3] Including printed circuit boards and components, such as resistors, capacitors, inductors, integrated circuits, etc

[4] Including water tanks and pipes

- ⚠ 1. "Exceeding 0.1 wt%" and "Exceeding 0.01 wt%" indicate that the content of restricted substances exceeds the percentage concentration limit.
- 2. "○" indicates that the content of the restricted substance does not exceed the percentage concentration limit.
- 3. "—" indicates that the restricted substance is exempted.

All GUNGDAI's products have two years warranty from the date of purchase and installation (excluding water filtration equipment). If repairs are needed, please contact the selling distributor.

There are situations where repairs may incur charges during the warranty period, as outlined below:

- If the usage does not comply with the instructions.
- If used with sources other than general tap water, such as unfiltered water.
- Damage caused by dropping or other human factors after purchase.
- If the warranty certificate does not record the purchase date, customer name, or store name, or if it has been altered.
- Malfunctions caused by natural disasters such as earthquakes, floods, or fires.
- If the filter materials are not replaced according to the company's specified schedule.
- If there is no warranty certificate.



GUNGDAI TECHNOLOGY CO., LTD.  
 17F., NO. 2-106, WUQUAN RD., WEST DIST., TAICHUNG TAIWAN, 40355  
<https://www.gungdai.com.tw/en>